

SITE TABLE					
TYPE	DEPTH	SHORTS	BATH	TERRACE	CORRIDOR
TILING	Terrazo	Terrazo	Cerami	Terrazo	Terrazo
WALL	Fliese	Fliese	Fliese	Fliese	Fliese
CEILING	Fliese	Fliese	Fliese	Fliese	Fliese

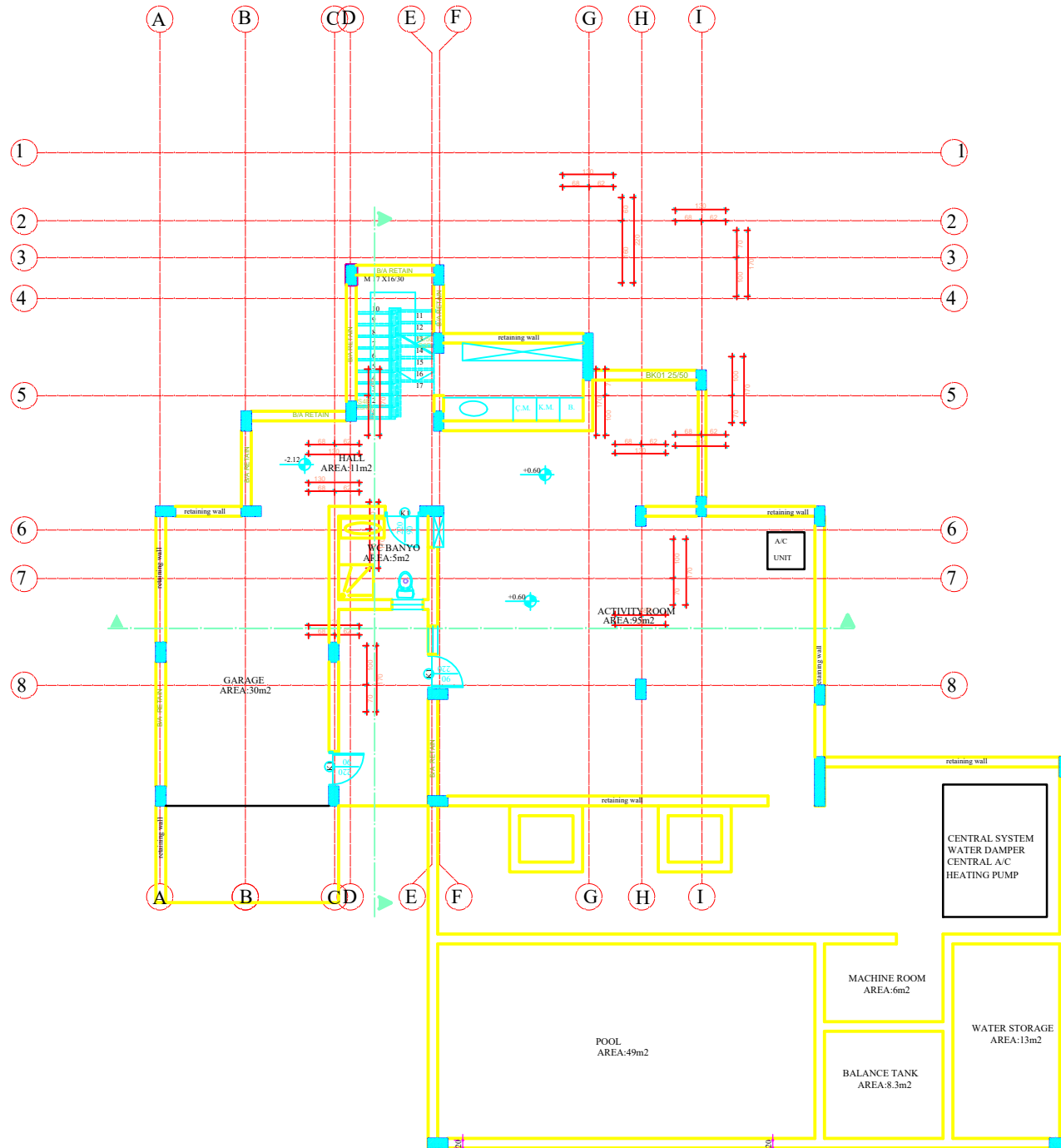

BASEMENT PLAN SCALE:1/50
GROSS AREA:62m²

OWNER			
HOŞEYİN SİCİMOĞLU AND OTHERS			
PROJECT OWNERS	Name/Surname	Profession	Reg. No. Sign.
Architectural Proj	TANUR SİDDİK	Architect	515
Static Project	MEHMET EMINOĞLU	Civ. Eng.	99-07
SHEET NO	SHEET NAME	SCALE	DATE
MO2	BASEMENT FLOOR PLAN	1/50	June 2005
TYPE-B			

SITE TABLE						
TYPE	LIVING ROOM	KITCHEN	BATH	TERRACE	BEDROOM	CORRIDOR
FLOORING	Tile	Tile	Tile	Tile	Tile	Tile
WALL	Plaster + Paint	Plaster + Paint	Plaster + Paint	Plaster + Paint	Plaster + Paint	Plaster + Paint
CEILING	Plaster + Paint	Plaster + Paint	Plaster + Paint	Plaster + Paint	Plaster + Paint	Plaster + Paint

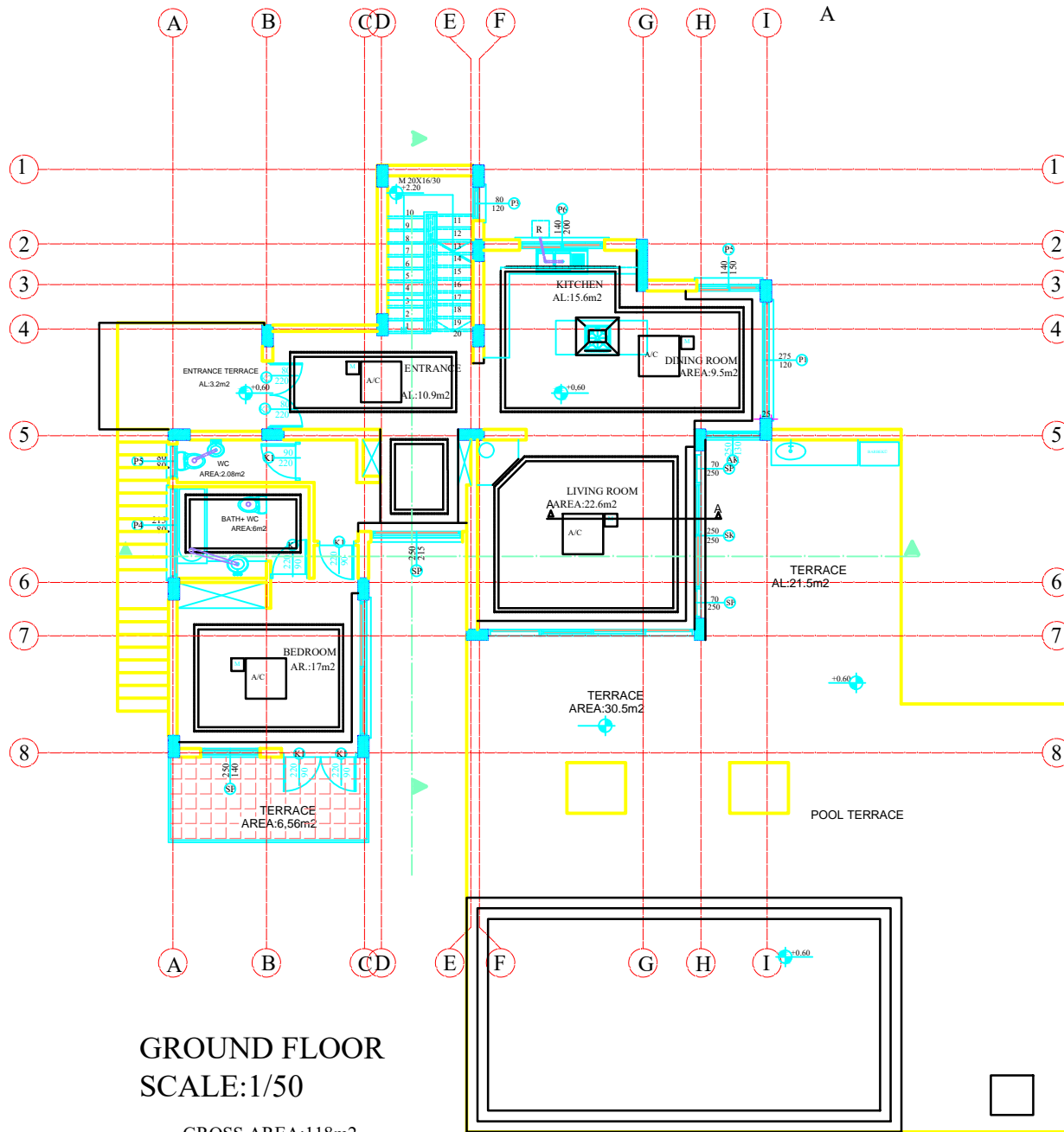

GROUND FLOOR
SCALE:1/50

GROSS AREA:118m²

OWNER	HOUSING PROJECT OF HESEYIN SIKIROGLU AND OTHERS		
PROJECT OWNERS	Name/Surname	Profession	Reg. No. Sign.
Architectural Proj.	TANUR, SIDDIK	Architect	515
Static Project	MEHMET EMINOGLU	Civ. Eng.	99-07
SHEET NO.	SHEET NAME	SCALE	DATE
M03 TYPE-B	GROUND FLOOR PLAN	1/50	June 2005

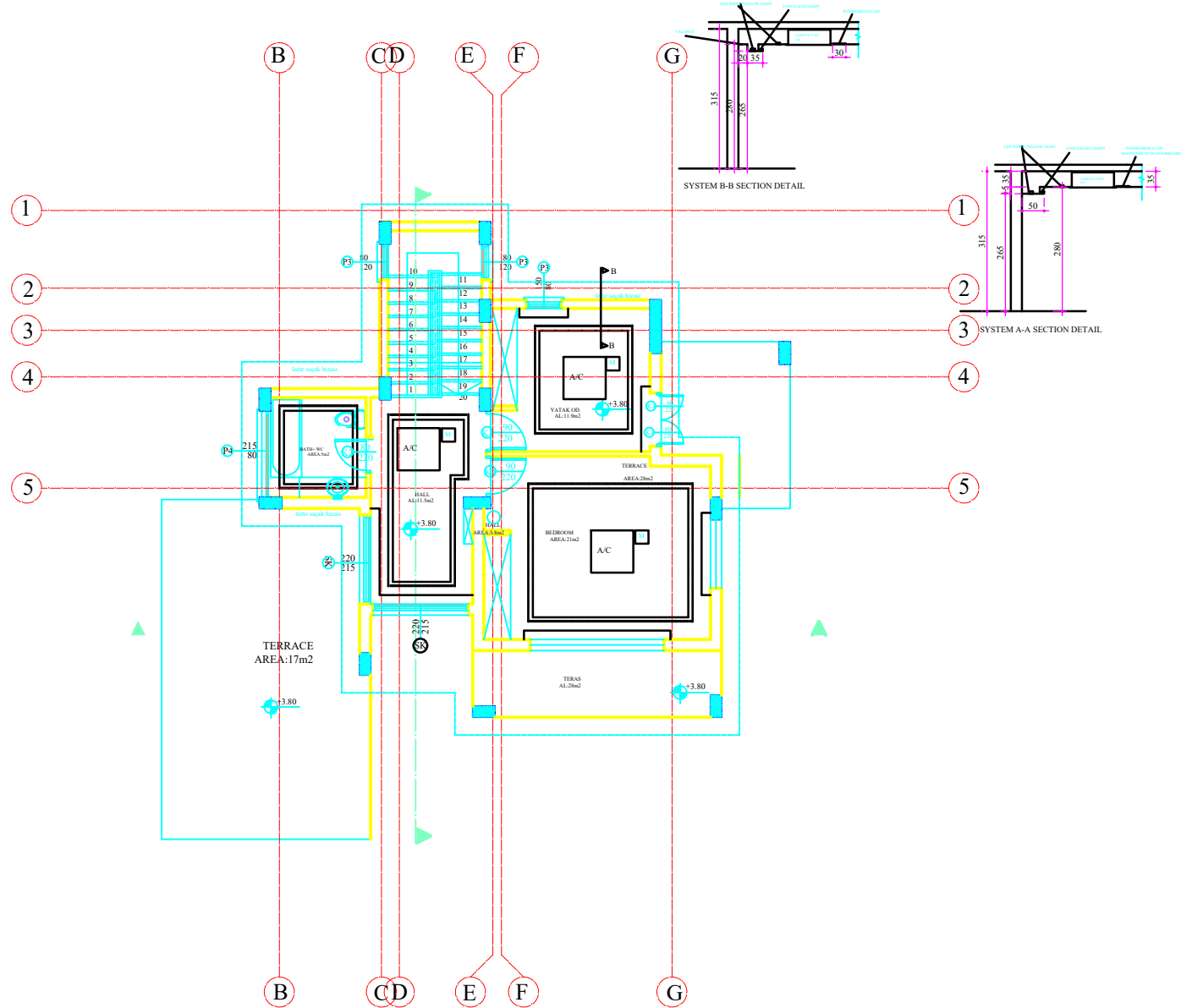

I. FLOOR PLAN
 SCALE:1/50
 GROSS AREA:40m2

OWNER		HOUSING PROJECT OF HÜSEYİN SİCİMOĞLU AND OTHERS		
PROJECT OWNERS	Name/Surname	Profession	Reg. No.	Sign.
Architectural Proj.	TANUR SİDDİK	Architect	515	
Static Project	MEHMET EMINOĞLU	Civ. Eng.	99-07	
SHEET NO	SHEET NAME	SCALE	DATE	
MO3	I. FLOOR PLAN	1/50	June 2005	
TYPE-B				

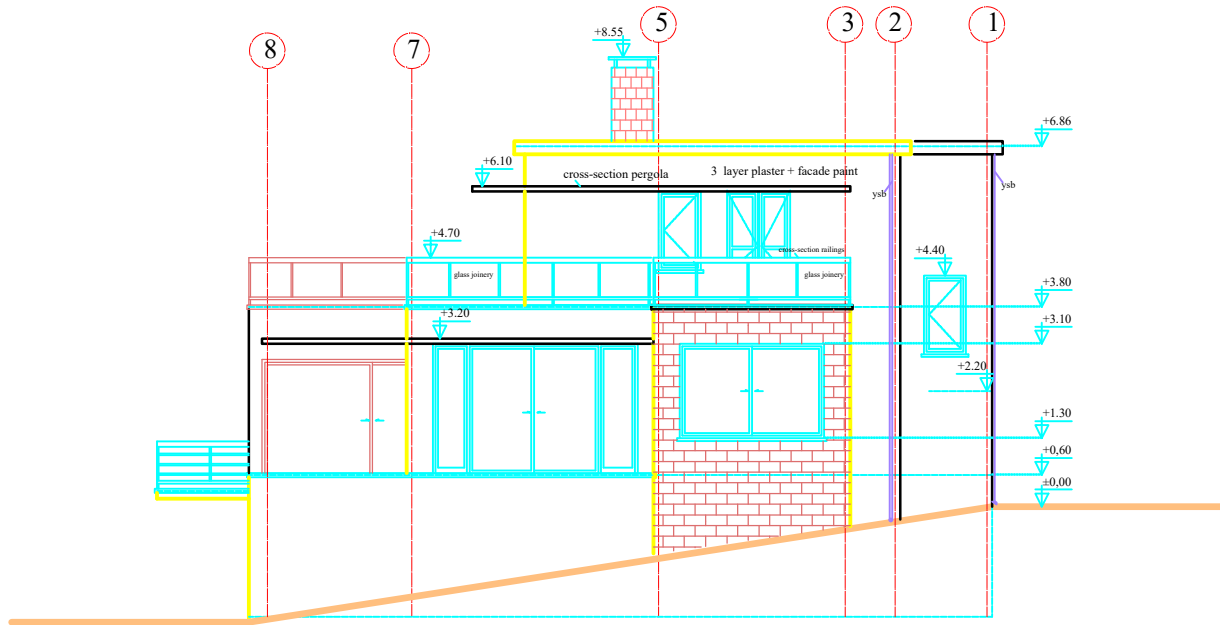

REAR PLAN

SCALE:1/50

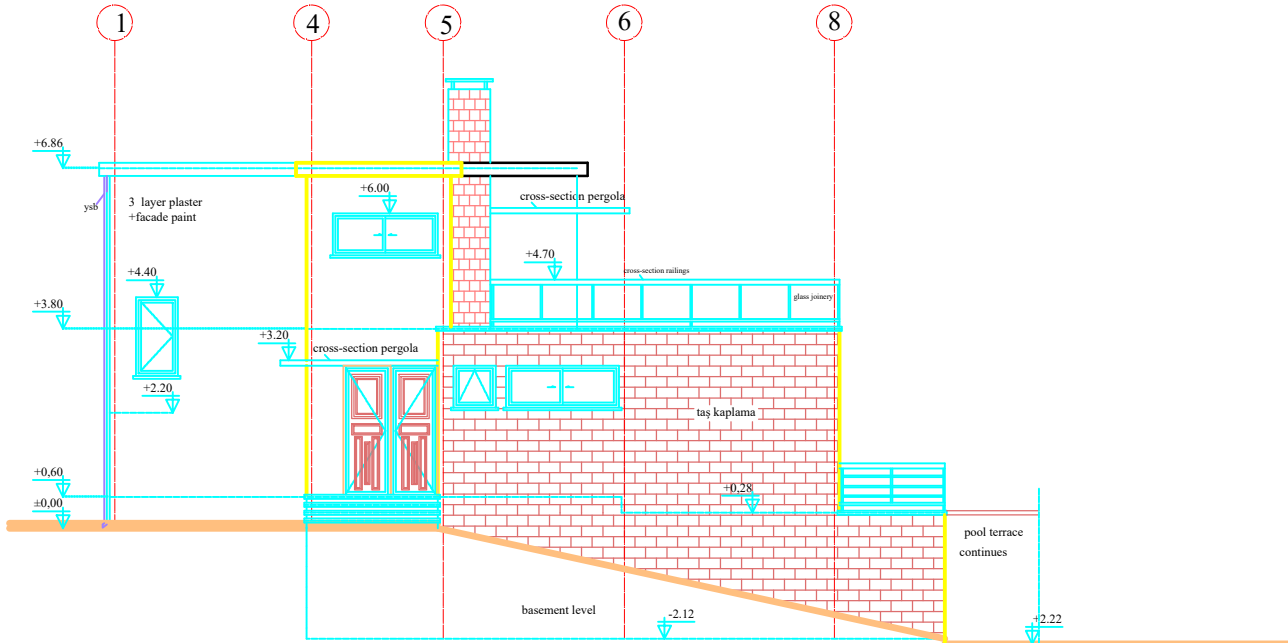

FRONT PLAN

SCALE:1/50

OWNER		HOUSING PROJECT OF HÜSEYİN SİCİMOĞLU AND OTHERS		
PROJECT OWNERS	Name/Surname	Profession	Reg. No.	Sign.
Architectural Proj.	TANUR SİDDİK	Architect	515	
Static Project	MEHMET EMİNOĞLU	Civ. Eng.	99-07	
SHEET NO	SHEET NAME	SCALE	DATE	
MO3	REAR & FRONT PLAN	1/50	June 2005	
TYPE-B				

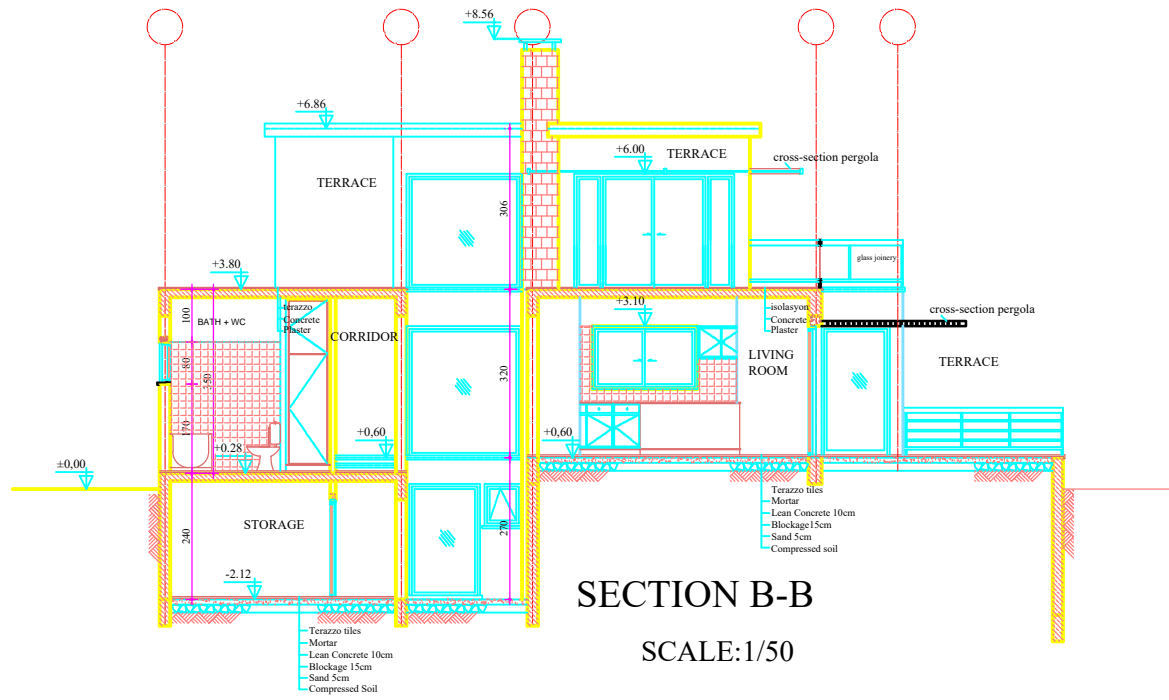

SECTION B-B

SCALE:1/50

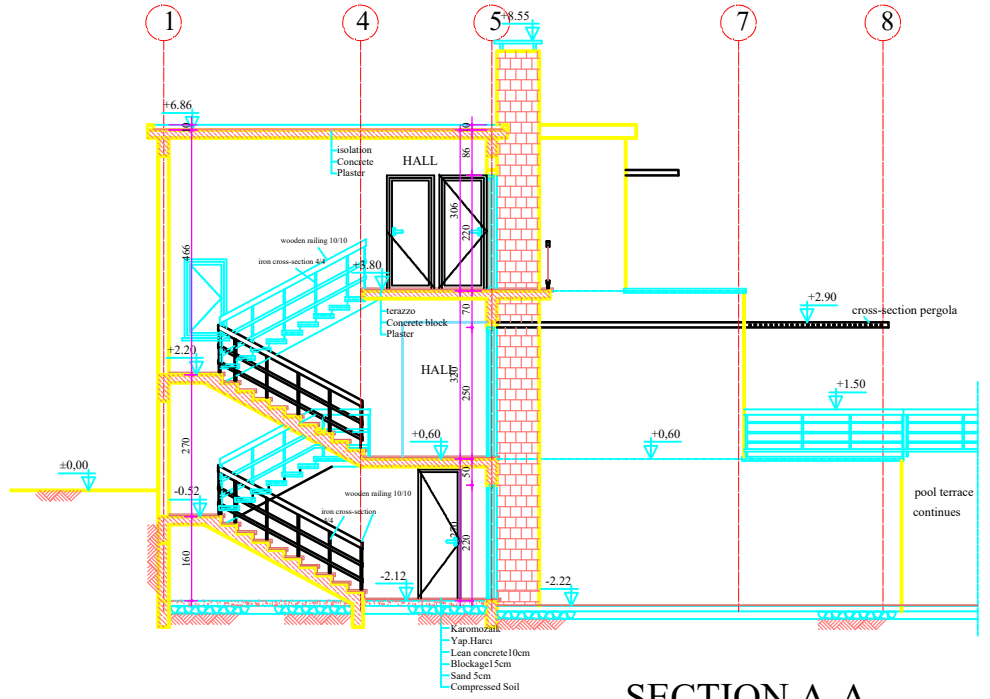

SECTION A-A

SCALE:1/50

OWNER	HOUSING PROJECT OF HÜSEYİN SİCİMOĞLU AND OTHERS		
PROJECT OWNERS	Name/Surname	Profession	Reg. No. Sign.
Architectural Proj.	TANUR SİDDİK	Architect	515
Static Project	MEHMET EMİNOĞLU	Civ. Eng.	99-07
SHEET NO	SHEET NAME	SCALE	DATE
MO3	SECTIONS	1/50	June 2005
TYPE-B			

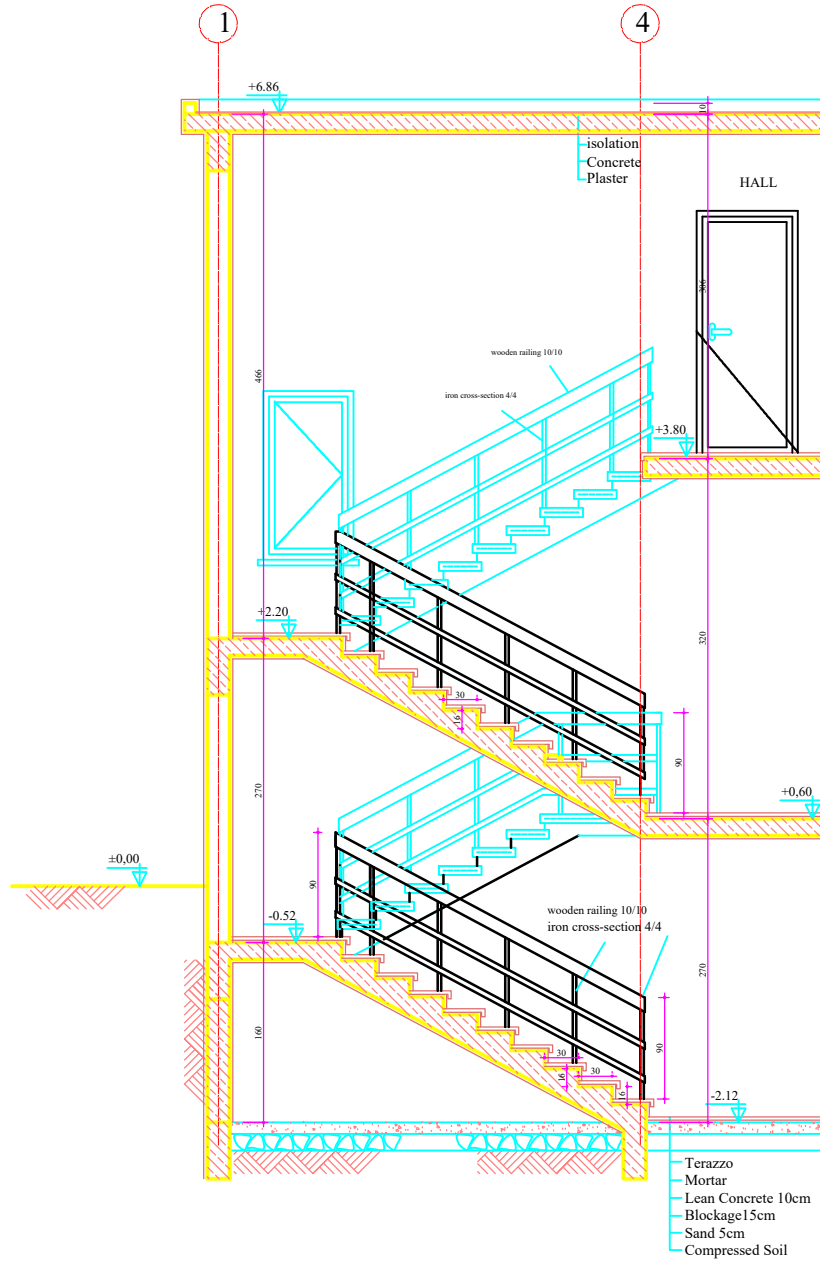

SECTION A-A DETAILED PLAN

SCALE:1/20

OWNER		HOUSING PROJECT OF HÜSEYİN SİCIMOĞLU AND OTHERS		
PROJECT OWNERS	Name/Surname	Profession	Reg. No.	Sign.
Architectural Proj.	TANUR SİDDİK	Architect	515	
Static Project	MEHMET EMİNOĞLU	Civ. Eng.	99-07	
SHEET NO	SHEET NAME	SCALE	DATE	
MO3 TYPE-B	ESCALIER SECTION PLAN	1/50	June 2005	

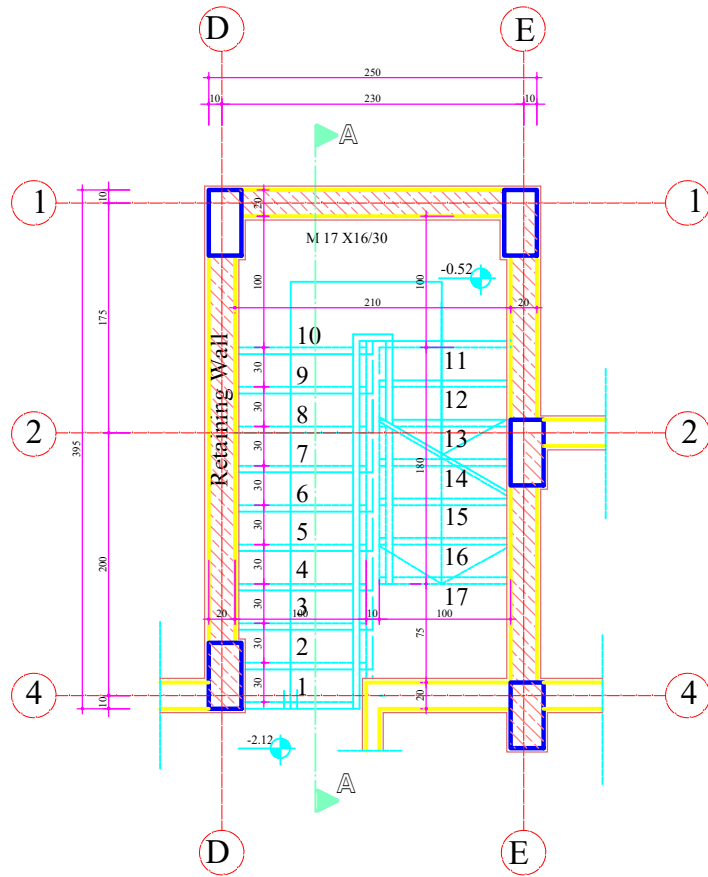

BASEMENT FLOOR PLAN

SCALE:1/20

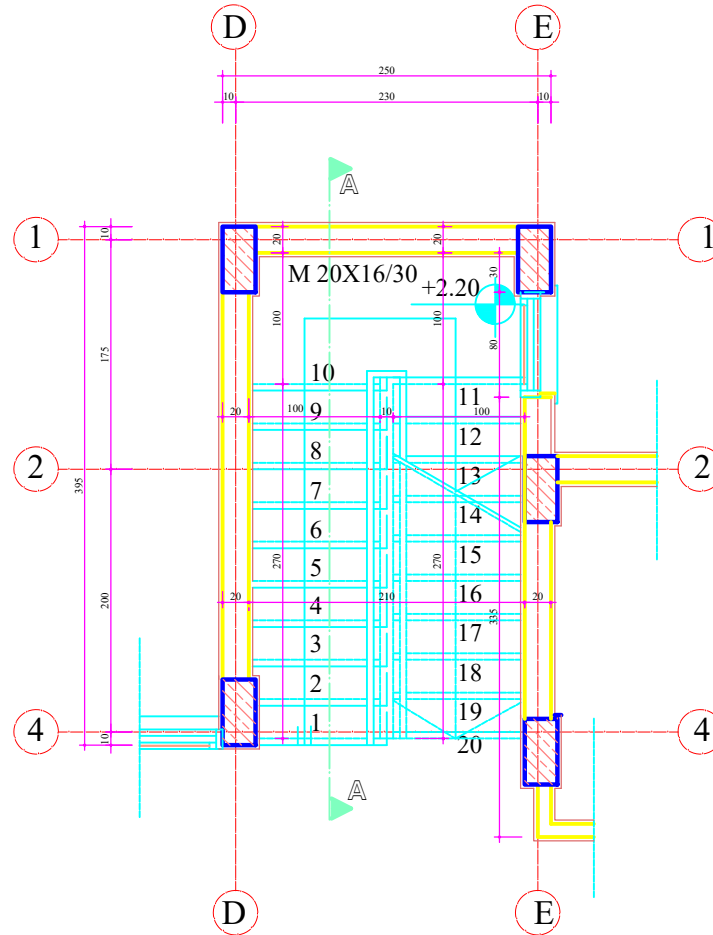

GROUND FLOOR PLAN

SCALE:1/20

OWNER		HOUSING PROJECT OF HÜSEYİN SİCİMOĞLU AND OTHERS		
PROJECT OWNERS	Name-Surname	Profession	Reg. No.	Sign.
Architectural Proj.	TANUR SİDDİK	Architect	515	
Static Project	MEHMET EMİNOĞLU	Civ. Eng.	99-07	
SHEET NO.	SHEET NAME	SCALE	DATE	
MO3	ESCALIER DETAILED PLAN	1/50	June 2005	
TYPE-B				